

If the Starboard backing for the Axiom 9s is one piece:
Can I get a 7"h 3.5"w 3/8" d cutout in between the screens
with a 1/2"w 3/8"d cut centered to the bottom of the
starboard? (Phone holder)

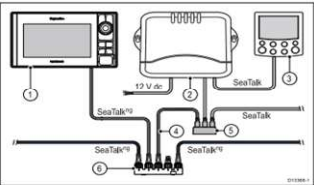

1. SeaTalk[®] MFD (MFDs require a separate power supply.)
2. SeaTalk autopilot (powered directly)
3. SeaTalk pilot controller (powered from the SeaTalk autopilot.)
4. SeaTalk-SeaTalk[®] adaptor cable (A22164) (connection to separated SeaTalk spur.)
5. SeaTalk 3-way block
6. SeaTalk-SeaTalk[®] converter (powered from the SeaTalk autopilot.)

Current Configuration

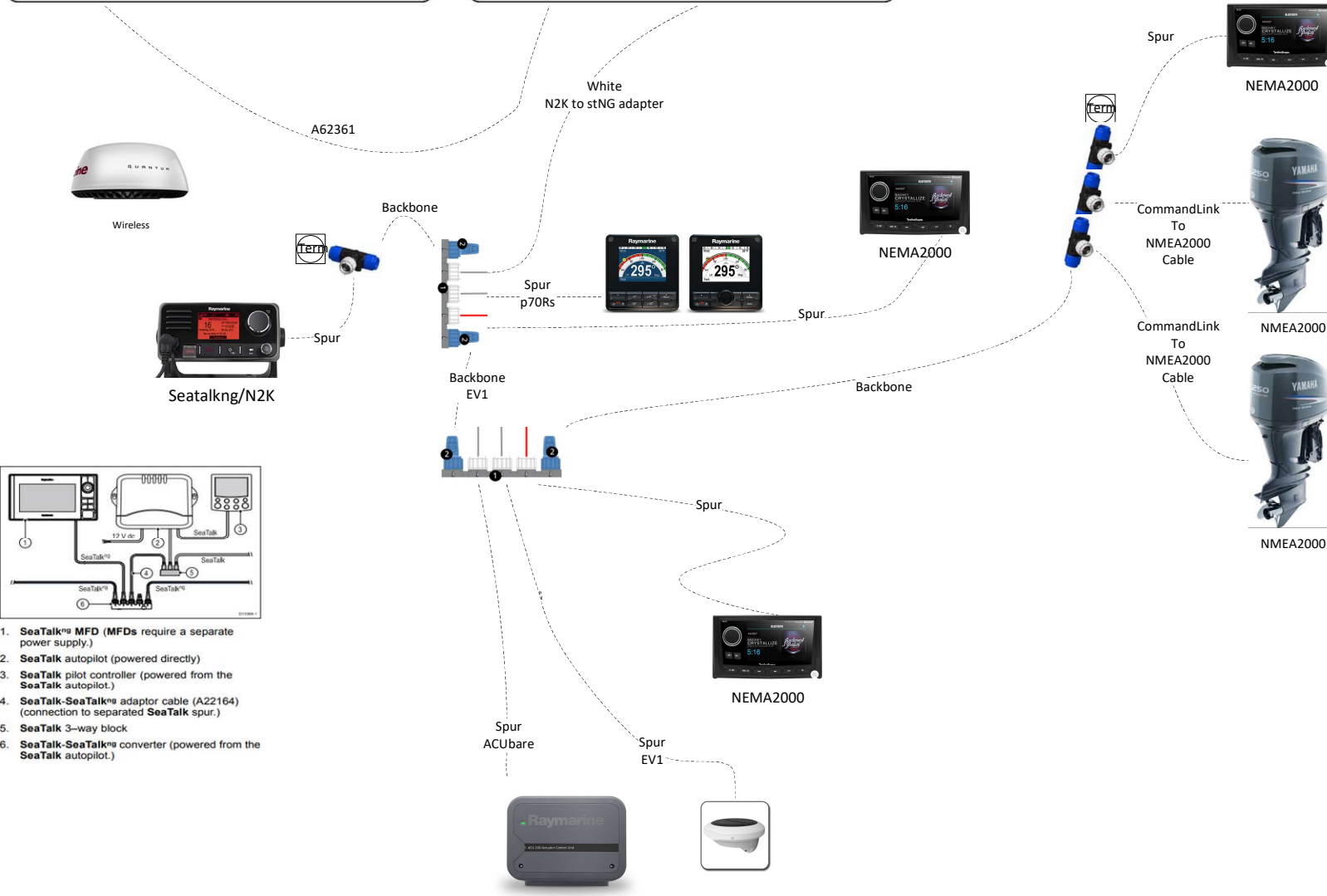
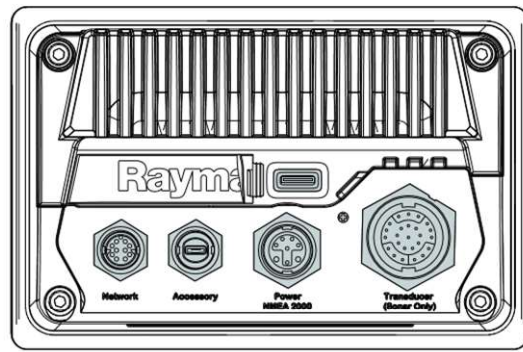
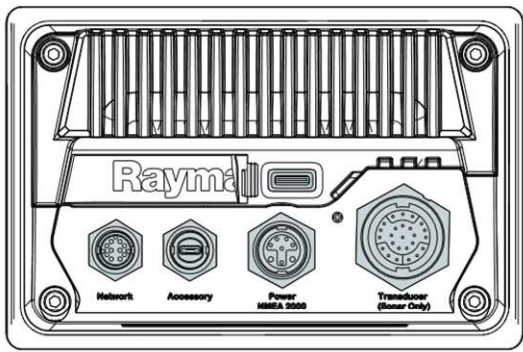
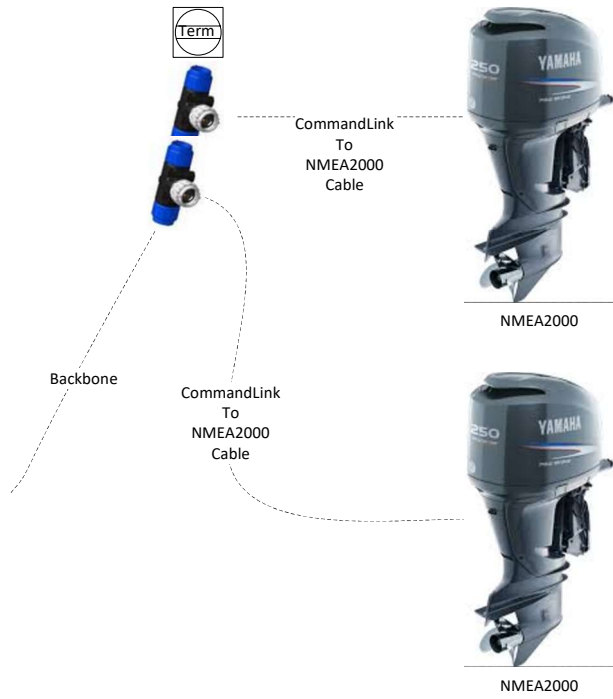

Proposed Configuration

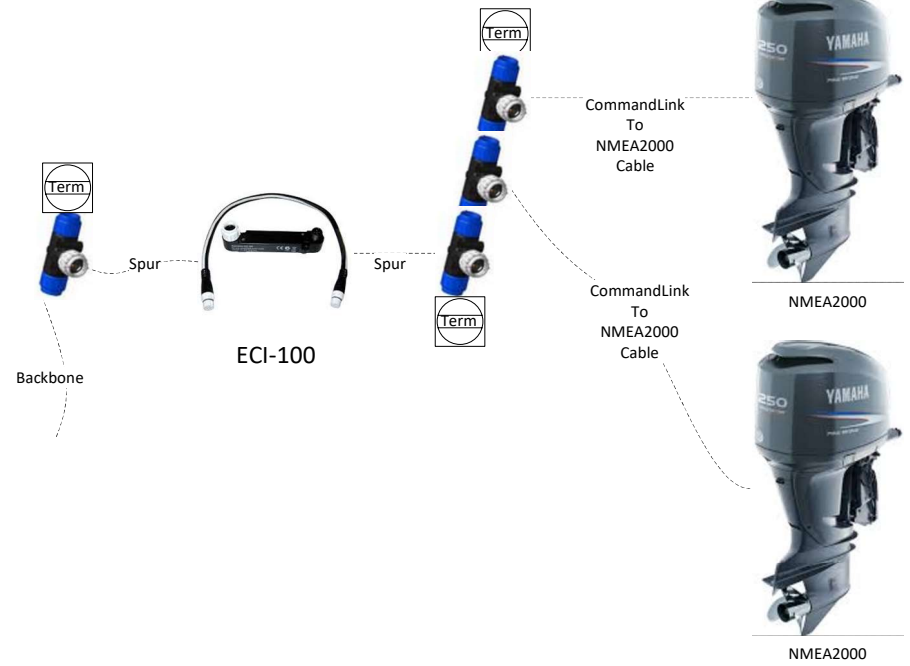

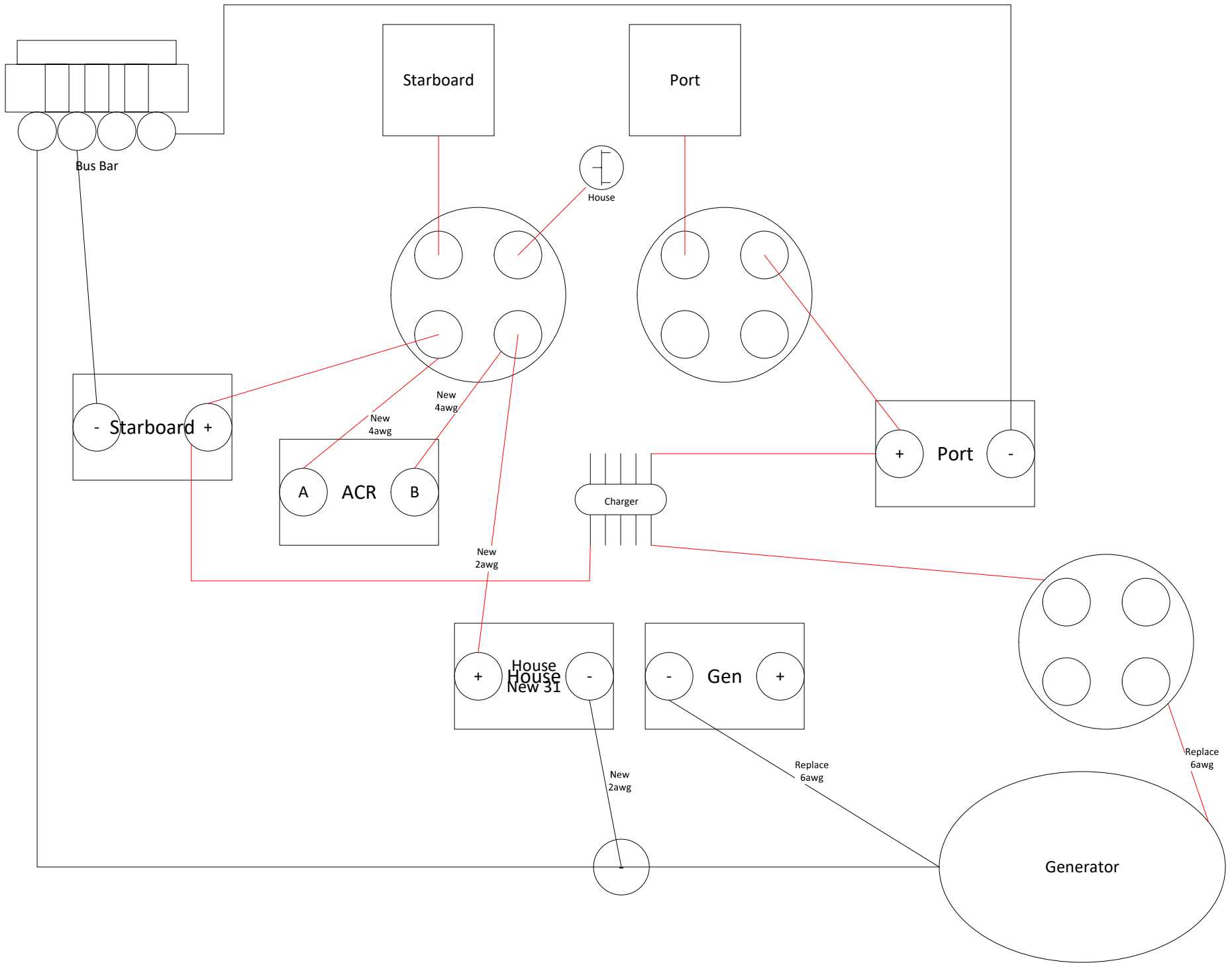

Coot 12V DC Wiring Diagram

